

# eBore™

## Bridge S/L

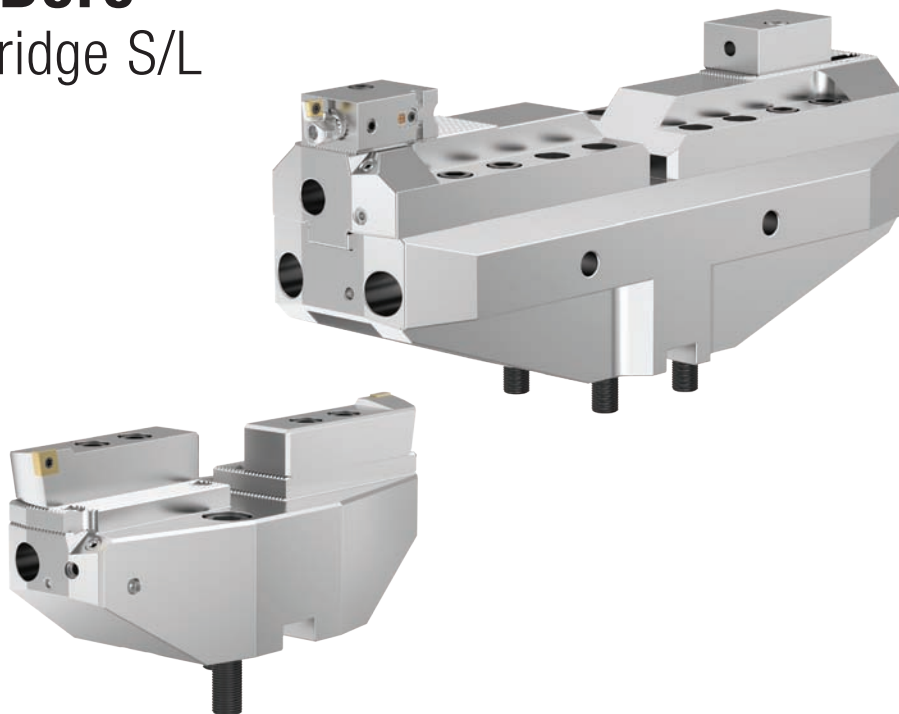

**Operating instruction eBore Bridge S/L**  
**for rough and finish machining**  
for  $\varnothing$  200–1020mm

<b>Contents</b>	Page
<b>1. Safety Information</b>	3
<b>2. Application</b>	3
<b>3. Operation</b>	3–4
3.1 Base slide, serrated slide	3–4
3.2 Insert holder	4
3.3 Precision boring tools Fine Boring Slide	4
3.4 Counterweight	4
<b>4. Internal Cooling Lubricant Supply</b>	5
<b>5. Maintenance</b>	5
<b>6. Accessories and Spare parts</b>	5–7
6.1 eBore Bridge S, Ø 200 – 505 mm	5
6.2 eBore Bridge L, Ø 465 – 1020 mm	6
6.3 Insert holder	6
6.4 Precision boring tool Fine Boring Slide	7
6.5 Clamping elements	7
6.6 Screws for securing inserts	7
6.7 Service keys	7
<b>7. Technical data</b>	8
7.1 Max. permissible speed	8

---

## 1. Safety Information



**Before using these tools for the first time, please read the operating instructions carefully. These provide important safety information and information concerning use and maintenance of the tool.**

These tools are designed for machining metallic materials. Specific information on the machining of individual metallic materials is not the subject of these operating instructions. Any other application is impermissible and could be dangerous. The manufacturer cannot be held responsible for damage or injury caused by improper use. A damaged tool could endanger your safety! Decommission the tool immediately and contact your supplier. This tool complies with the prescribed safety regulations. Repairs must be undertaken only by trained personnel. Improper repairs can represent a considerable risk for the user. Warranty provisions can be implemented in the event that original Erickson spare parts and accessories are used. Keep the operating instructions in a safe place for future use.

## 2. Application

The boring tool in aluminum can be used for rough machining (roughing) and finish machining (precision bores).

### Two series are available:

**eBore Bridge S** with a D 60 connection consists of 4 serrated slides covering the boring range from **Ø 200 – 505 mm**.

**eBore Bridge L** with a D 60 connection consists of 2 base slides covering the boring range from **Ø 465 – 1,020 mm**.

## 3. Operation

### 3.1 Base slides, serrated slides

A suitable (!) **master shank** is to be selected for holding the tool in the machine. We recommend consulting the machine and tool manufacturer for this purpose. The base slide or serrated slide is fastened to the master shank via a D 60 connection.

#### **eBore Bridge S:**

*Ø 200 – 505 mm:*

Individual serrated slides, adjustment of the add-on tools by means of threaded pin in the serrated slide.

#### **eBore Bridge L:**

*Ø 465 – 1,020 mm:*

The base slide and the serrated slide are joined using a groove-and-tongue connection. Fastening is with four cap screws and two clamping bolts. The desired boring Ø is then preset via the scale.

The **add-on tools** (blade carriers and counterweights) are then fastened on all serrated slides with cap screws and clamping bolts. Please note: The clamping bolt must be installed so that the flat part points in the direction of the screw head. This principle applies to all clamping bolt fastening points. The exact adjustment is made with an adjusting device, via a gage or via a distance measurement with the aid of an auxiliary fixture. With the eBore Bridge L series, Ø presetting via a measuring pin is possible for Ø 465 mm and larger.

All parts must be cleaned prior to installation and then installed in a dry and grease-free state.

Only original Erickson clamping elements are permissible for fastening all components of this boring tool. See „Accessories and spare parts“ from page 12 for tightening torques.

**eBore Bridge S,**  
Ø 200 – 505 mm

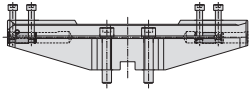

**eBore Bridge L,**  
Ø 465 – 1,020 mm

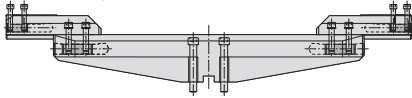

See „Accessories and spare parts“ from page 12 for detail illustrations.

**3.2 Insert holder**

*Fastening:*

The insert holder is fastened on the serrated slide with serrated front face using cap screws and clamping bolts. As an adjustment aid, there are scales on the insert holders and serrated slides.

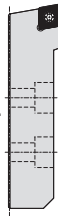

**3.3 Precision boring tool**

The precision boring tool assembly comprises a precision boring tool (1), an insert holder (3) and the clamping elements (2) (4) (5) (6).

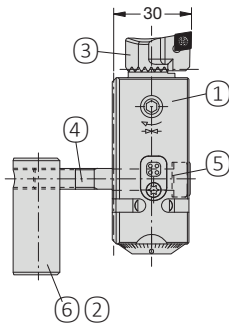

Precision boring tool Fine Boring Slide

*Fastening:*

The clamping elements (supplied as standard) of the serrated slides are to be replaced with the clamping elements for the precision boring tools.

The precision boring tool is fastened on the serrated slide with serrated front face using cap screw (4), disc spring (5) and clamping bolt (6). Please note: the long side of the clamping bolt has to be mounted turned away from the cutting edge, with the flat part pointing in the direction of the screw head. As an adjustment aid, there are scales on the serrated slides holders and precision boring tools.

*Operation of precision boring tools:*  
see separate operating instructions for Fine Boring Slide 6655302.

**3.4 Counterweight**

The counterweight serves to avoid imbalance when boring precision bores. The counterweight assembly comprises the counterweight (7) and the clamping elements (9) (10) (11).

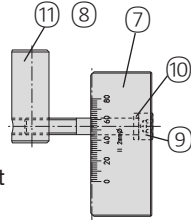

*Fastening:*

The clamping elements (supplied as standard) of the serrated slides are to be replaced with the clamping elements for the counterweights.

The counterweight is fastened on the serrated slide with serrated front face using cap screw (9), disc spring (10) and clamping bolt (11). Note that the long side of the clamping bolt is mounted in the direction of the tool center. As an adjustment aid, there are scales on the serrated slides holders counterweights.

**4. Internal Cooling Lubricant Supply**

The eBore tools designed as standard for internal cooling lubricant supply. An adjustable spray nozzle element on the outer end of the base slide or serrated slide can be aimed at the cutting edge. The cooling lubricant pressure must not exceed 40 bar.

**5. Maintenance**

No maintenance!

To ensure the tool has a long service life, it must be cleaned after use. A light film of oil should be applied to the visible, uncoated steel parts from time to time.

**6. Accessories and Spare Parts**

Accessories are not included in the scope of delivery and they must be ordered separately. Information on accessories is available in the Erickson product catalog and on the Internet at: [www.kennametal.com](http://www.kennametal.com)

**6.1 eBore Bridge S, Ø 200 – 505 mm**

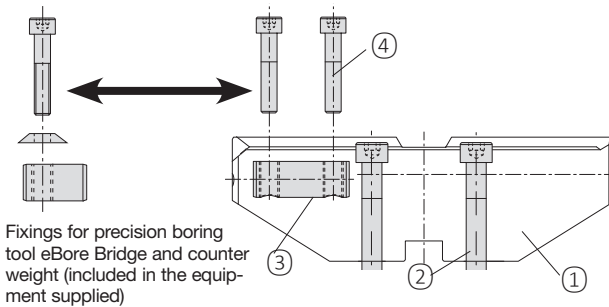

Serrated slide ① Part No.	Cap screw ② Part No.	Key (torque)	Clamping-bolt ③ Part No.	Cap screw ④ Part No.	Key (torque)
6655282	<b>6763430</b>	s14/DIN911 (65 Nm)	<b>6738784</b>	<b>3905828</b>	s8/DIN911 (35 Nm)
6655284	<b>6763430</b>	s14/DIN911 (65 Nm)	<b>6738784</b>	<b>3905828</b>	s8/DIN911 (35 Nm)
6655285	<b>6763430</b>	s14/DIN911 (65 Nm)	<b>6738784</b>	<b>3905828</b>	s8/DIN911 (35 Nm)
6655286	<b>6763430</b>	s14/DIN911 (65 Nm)	<b>6738784</b>	<b>3905828</b>	s8/DIN911 (35 Nm)

65 Nm = 575.30 in.lbs

35 Nm = 309.78 in.lbs

**6.2 eBore Bridge L, Ø 465 – 1020 mm**

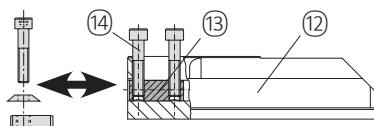

Fixings for precision boring tool eBore Bridge and counter weight (included in the equipment supplied)

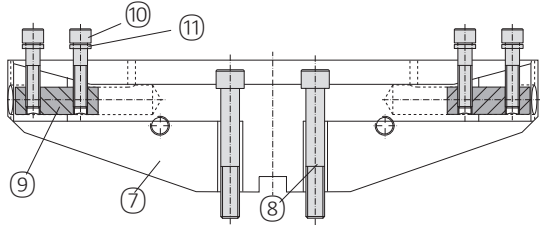

Basic slide (7)	Cap screw (8) Part No. Key (torque)	Clamping bolt (9) Part No.	Cap screw (10) Part No. Key (torque)	Disc (11) Part No.	Serrated slide (12) Part No.	Clamping bolt (13) Part No.	Cap screw (14) Part No. Key (torque)
6655287	<b>6763429</b> s14/DIN911 (65 Nm)	<b>6738793</b>	<b>3487687</b> s10/DIN911 (55 Nm)	<b>6763469</b>	<b>6655288</b>	<b>6738784</b>	<b>3905828</b> s8/DIN911 (35 Nm)
6655289	<b>6763429</b> s14/DIN911 (65 Nm)	<b>6738793</b>	<b>3487687</b> s10/DIN911 (55 Nm)	<b>6763469</b>	<b>6655288</b>	<b>6738784</b>	<b>3905828</b> s8/DIN911 (35 Nm)

65 Nm = 575.30 in.lbs.

55 Nm = 486.79 in.lbs.

35 Nm = 309.78 in.lbs.

Part No. for (12) incl. (13) and (14).

**Measuring pin**

(only for boring range larger than 465 – 1020 mm)

Measuring pin is included in the delivery.

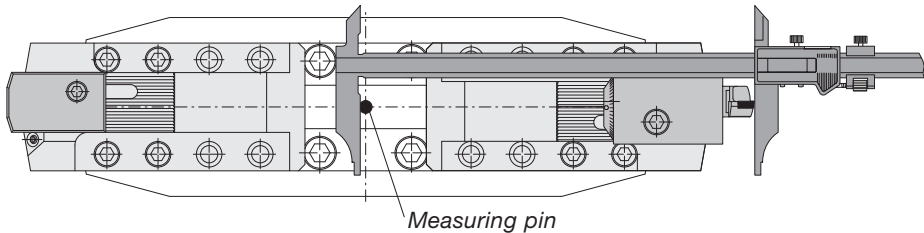

**6.3 Insert holder**

Insert holders for diverse applications and diverse reversible insert types: see catalog and [www.kennametal.com](http://www.kennametal.com).

**6.4 Precision boring tools Fine Boring Slide**

See Operating Instructions Fine Boring Slide 6655302.

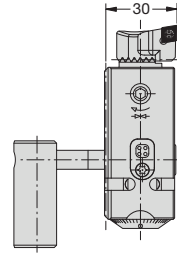

**6.5 Clamping elements (Cap screw, Clamping bolts, Disc spring)**

Applications and boring ranges	Clamping elements	Key (torque)
	Order No.	
<b>eBore Bridge S/L</b> 200-1020 mm	6655304	s6 / DIN911 (25 Nm)

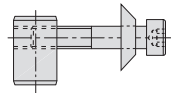

**6.6 Fastening screws for the most common indexable inserts**

Insert form	Countersunk screw ① Part No.	Service key, torx (torque)		
		Nm	in.lbs.	
CC..06	<b>115676</b>	T 8/H	1.2	10.62
CC..09	<b>115673</b>	T 15/H	3.0	25.55
CC..12	<b>215149</b>	T 20/H	5.0	44.25

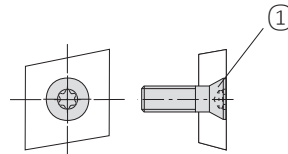

**6.7 Service keys**

Service keys are included in the delivery.

Service keys / Type	Part No.
s6 / DIN911	<b>1138331</b>
s8 / DIN911	<b>1135984</b>
s10 / DIN911	<b>1138340</b>
s14 / DIN911	<b>1138380</b>

Type DIN911

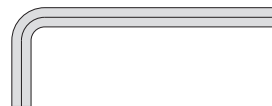

Service keys, Torx / Typ	Part No.
T 8 / FT	<b>1021593</b>
T 15 / FT	<b>1021605</b>
T 20 / FT	<b>1021607</b>

Type FT



## 7. Technical data

### 7.1 Max. permissible speeds:

- The speeds stated are designed for a symmetrical tool design. Asymmetrical designs reduce values by 50%.
- Short overhangs reduce concentricity errors as well as imbalance. This increases the life of the spindle and improves safety.
- Suitable protective devices or machine enclosures must be provided against flying particles and cutter breakage.

- The mounting and fixing screws required must be checked for correct tightness before work is started.
- Ensure that the tool is balanced to the manufacturer's requirements.

**In principle, max. permissible speeds involve a risk due to the centrifugal energies involved. It is therefore essential to take the safety aspects into account.**

#### eBore Bridge S, Ø 200 – 505 mm

Boring range Ø mm	Serrated slide		Max. permissible speed in rpm
	Part No.	Weight	
200 – 280	6655282	4,1 kg / 9.0 lbs	1500
275 – 355	6655284	5,2 kg / 11.5 lbs	1100
350 – 430	6655285	6,9 kg / 15.2 lbs	850
425 – 505	6655286	8,0 kg / 15.2 lbs	700



#### eBore Bridge L, Ø 465 – 1020 mm

Boring range Ø mm	Basic slide		Serrated slide		Max. permissible speed in rpm
	Part No.	Weight	Part No.	Weight	
465 – 605	6655287	11.8 kg / 26.0 lbs	6655288	5.9 kg / 13.0 lbs	650
605 – 745	6655287	11.8 kg / 26.0 lbs	6655288	5.9 kg / 13.0 lbs	500
740 – 880	6655289	18.0 kg / 39.7 lbs	6655288	5.9 kg / 13.0 lbs	400
880 – 1020	6655289	18.0 kg / 39.7 lbs	6655288	5.9 kg / 13.0 lbs	350

